

- Slim profile, for DIN-rail mounting
- Alternative side-mounting for flat panels
- High power factor by active power correction
- Very high efficiency up to 94.5%
- Back power immunity
- 150% peak current for 4 sec.
- Operating temperature range: -25°C to +70°C max.
- Adjustable output voltage
- DC-OK indicator
- Short circuit and overload protection



This generation of DIN-rail power supplies combines the most efficient circuit topology with optimized cost/performance ratio for industrial environments and for electrical control cabinets.

They have a very high efficiency of up to 94.5% which allows a very slim package design. The case offers the potentially useful feature to fix the DIN-rail clip to the side wall for the mounting inside flat panels. Over a period of minimum 4 seconds they can operate with a boost power of 150%. The boost power facilitates the activation of stepper motors, solenoids or actuators. The units operate with a high power factor of up to 99% by active power factor correction which also keeps the input inrush current low. The TIB series models are available with a nominal power of 80, 120, 240 or 480 Watt (+50% boost power). The output voltage is adjustable from 23.5 to 28 VDC. They come with the safety standard approvals for IEC/EN 60950-1, UL 60950-1 and UL 508.

Models				
Order Code	Output Power (max.)	Output Voltage nom. (adjustable)	Output Current (max.)	Efficiency (typ.)
TIB 080-124	80 W	24 VDC (23.5–28)	3.4 A	90.0 %
TIB 120-124	120 W	24 VDC (23.5–28)	5.0 A	93.5 %
TIB 240-124	240 W	24 VDC (23.5–28)	10 A	94.5 %
TIB 480-124	480 W	24 VDC (23.5–28)	20 A	94.7 %

For ATEX compliant models add appendix -EX to order code.

Input Specifications

Input voltage	– nominal ranges – effective ranges	100 – 240 VAC 85 – 264 VAC (below 90 VAC a derating of 3%/V is required)
Input voltage frequency		45 – 65 Hz
Standby power consumption	80 W model: 120 W model: 240 W model: 480 W model:	0.9/1.3 W (115/230 VAC) 1.9/1.6 W (115/230 VAC) 1.7/1.9 W (115/230 VAC) 3.8/3.8 W (115/230 VAC)
Power Factor Correction (PFC)	80 W model: 120 W model: 240 W model: 480 W model:	0.48/0.48 (115/230 VAC) 0.97/0.8 (115/230 VAC) 0.98/0.92 (115/230 VAC) 0.99/0.97 (115/230 VAC)
Harmonic limits	– acc. EN 61000-3-2	80 W model: class A 120–480 W models: class A, D
Inrush current		15/30 A max. (115/230 VAC)

Output Specifications

Output voltage adjustment ¹⁾		23.5 – 28.0 VDC
Regulation	– Input variation – Load variation (10–90 %)	0.1 % max. 0.5 % max.
Temperature coefficient		0.02 %/K
Hold-up time	80 W model: 120–480 W models:	20/160 ms min. (115/230 VAC) 20 ms min.
Start-up time		2 s max.
Ripple and Noise (20MHz bandwidth)		100 mVp-p max.
Output overvoltage protection (OVP) ²⁾	80–240 W models: 480 W model:	32 – 35 V 29 – 30 V
Power back immunity ³⁾		< OVP level
Operation	– Nominal operation – Peak power operation – Constant current (cc)	100 % of I _{out} nom. 105 – 150 % of I _{out} nom. 155 % of I _{out} nom.
Duty cycle ⁴⁾ (for peak and cc mode)	– Threshold – CC or peak operation timer – normal operation / off period	> 105 % 4 s max. (switch off) < 10 s (automatic restart after switch off or peak and cc operation timer reset)
Short circuit		Switch off after 4s delay, automatic restart
DC OK signal	– DC ON – DC OFF	V _{out} > 22.5 V typ. relay contact closed, max. 1 A, < 100mOhm V _{out} < 21.5 V typ. relay contact open, max 30 V

¹⁾ Output voltage can be adjusted as indicated. However, output power has to be maintained at nominal value. This means the output nominal current has to be reduced in accordance with the increase of output voltage.

²⁾ In case of an internal error a second voltage regulation loop keeps the output voltage at a safe level, the power supply turns off and restarts after 10 seconds.

³⁾ When external voltage is supplied above set output voltage and below OVP threshold, the power supply will function normally without switch off or destruction, even if external voltage is applied continuously.

⁴⁾ In case of overload or short circuit, the unit switches the output voltage off after 4 seconds and tries to restart every 10 seconds.

All specifications valid at nominal input voltage, full load and +25°C after warm-up time unless otherwise stated.

General Specifications

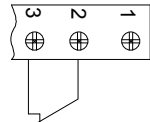
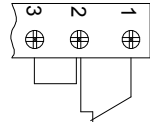
Operating temperature range		-25°C to +70°C max.
Derating		2 %/K above +60°C
Cooling		convection cooling, no internal fan
Overtemperature protection		switch off at overtemperature
Humidity (non condensing)		5–95 % rel. H max.
Altitude during operation		2000 m max.
Isolation Voltage	– Input/Ouput – Input/Chassis – Ouput/Chassis	4250 VDC 1500 VDC 750 VDC
Creepage Clearance	– Input/Ouput – Input/Chassis – Output/Chassis	8 mm 4 mm 1.5 mm
MTBF (acc. to IEC 61709 at 25°C)	80 W model: 120 W model: 240 W model: 480 W model:	> 1'950'000 h > 1'450'000 h > 1'300'000 h > 1'000'000 h
Safety standards	– Information technology equipment – Safety low voltage switchgear and controlgear – Control equipment for hazardous location – Certification documents	IEC/EN 60950-1, UL 60950-1 CSA 22.2 No 60950-1-03 UL 508 EN 60079-15 (EX II3G Ex ec nC IIC GC) www.tracopower.com/overview/tib
Electromagnetic compatibility (EMC), Emissions	– Conducted RI suppression on input – Radiated RI suppression	EN 61000-6-3, EN 61204-3 EN 55032, EN 55011 class B, EN 55032, EN 55011 class B
Electromagnetic compatibility (EMC), Immunity	– Electrostatic discharge (ESD) – Radiated RF field immunity – Electrical fast transient / burst immunity – Surge immunity – Immunity to conducted RF disturbances – Power frequency field immunity – Mains voltage dips and interruptions – Voltage sag immunity	EN 61000-6-2, EN 61204-3 IEC/EN 61000-4-2 4 kV/8 kV criteria A IEC/EN 61000-4-3 10 V/m criteria A IEC/EN 61000-4-4 2 kV criteria B IEC/EN 61000-4-5 1 kV/2 kV criteria B IEC/EN 61000-4-6 10 V criteria A IEC/EN 61000-4-8 30 A/m criteria A IEC/EN 61000-4-11 criteria B/C SEMI F47
Environment	– Vibration acc. IEC 60068-2-6-3 – Shock acc. IEC 60068-2-27	3 axis, 2 g sine sweep, 10–55 Hz, 11 okt/min 3 axis, 25 g half sine, 11 ms
Enclosure material	– Chassis – Cover	aluminium stainless steel
Mounting	– DIN-rail mounting	for DIN-rails as per EN 50022-35×15/7.5
Environmental compliance	– Reach – RoHS	www.tracopower.com/products/reach-declaration.pdf RoHS directive 2011/65/EU
Connection		screw terminals
Remote On/Off (480 W model only)	– contact rating – signal assignment	The unit can be controlled by external relay contact or open collector signal. open: 15V; leakage current max 100µA close: 0.3V; max drop at 15 mA Normal operation  Reversed operation  ON = open OFF = closed ON = closed OFF = open

Function Specification

Block Diagrams

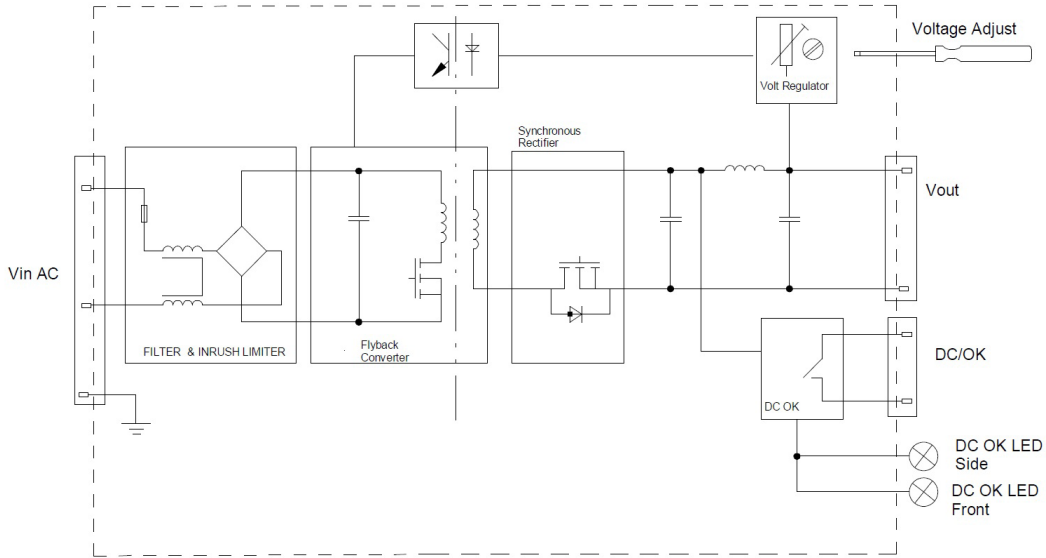

Circuit block diagram for TIB 80, wide range Flyback

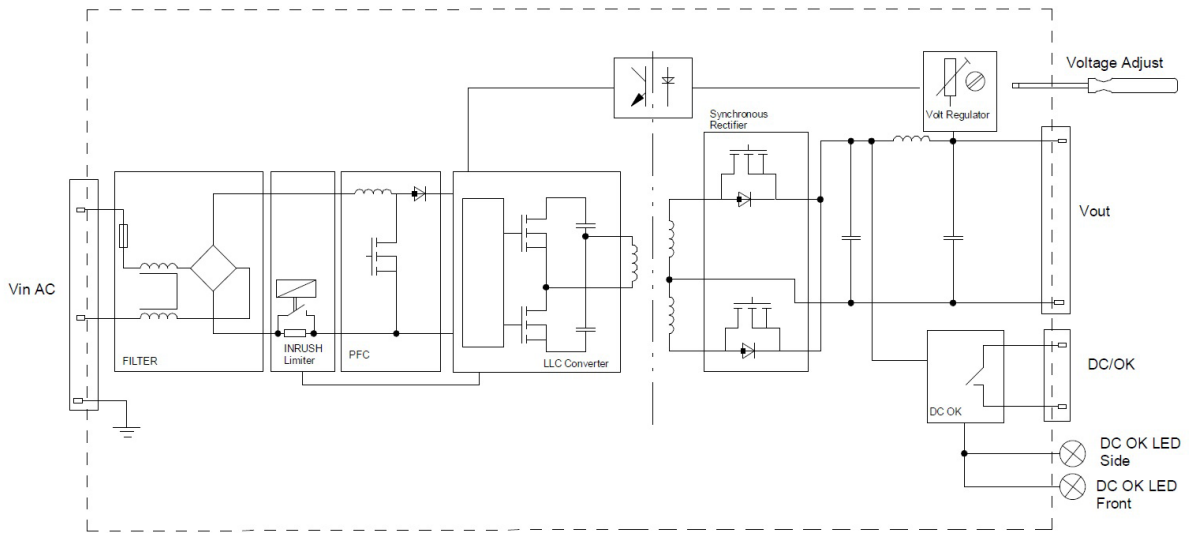

Circuit block diagram for TIB 120 and TIB 240

Function Specification (continued)

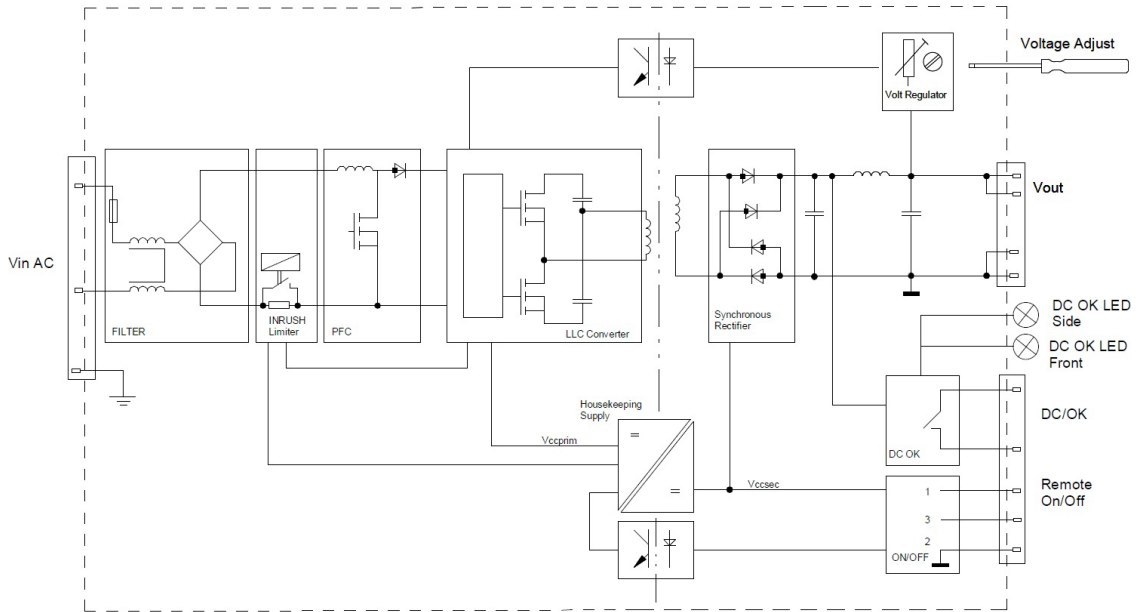

Circuit block diagram for TIB 480

Output Characteristic

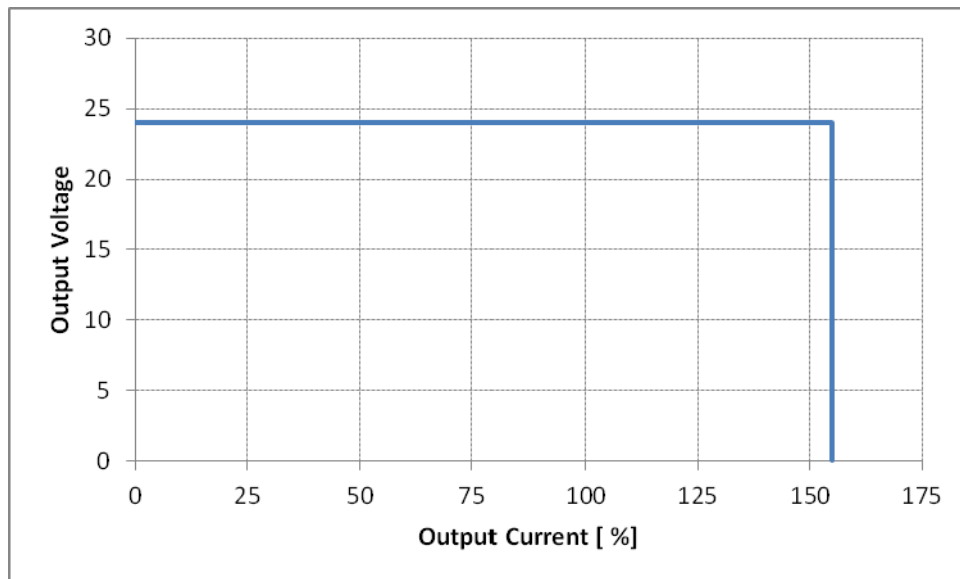

Characteristic: Output voltage vs output current for overload conditions until switch off after 4s at nominal input voltages

Output Characteristic (continued)

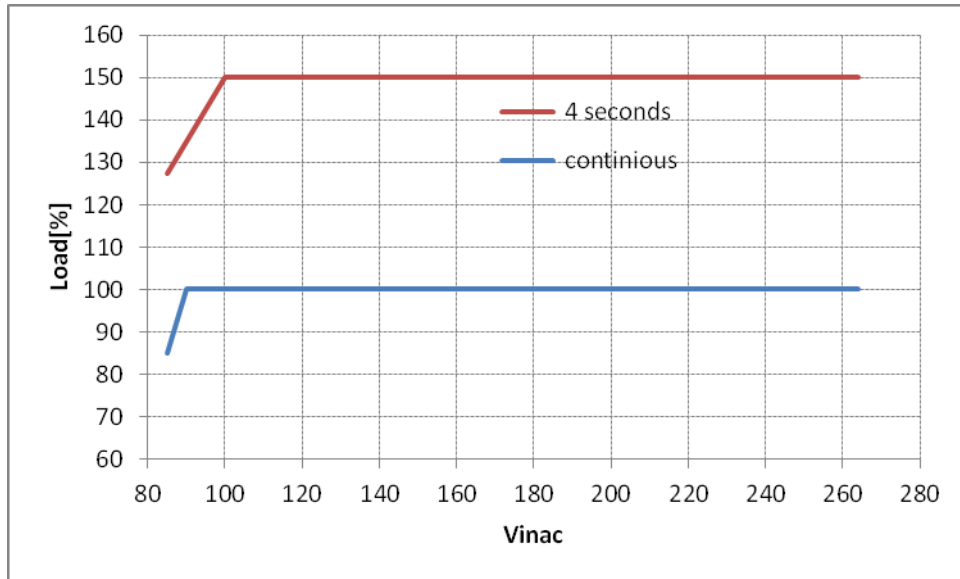

Derating: max load vs input voltage

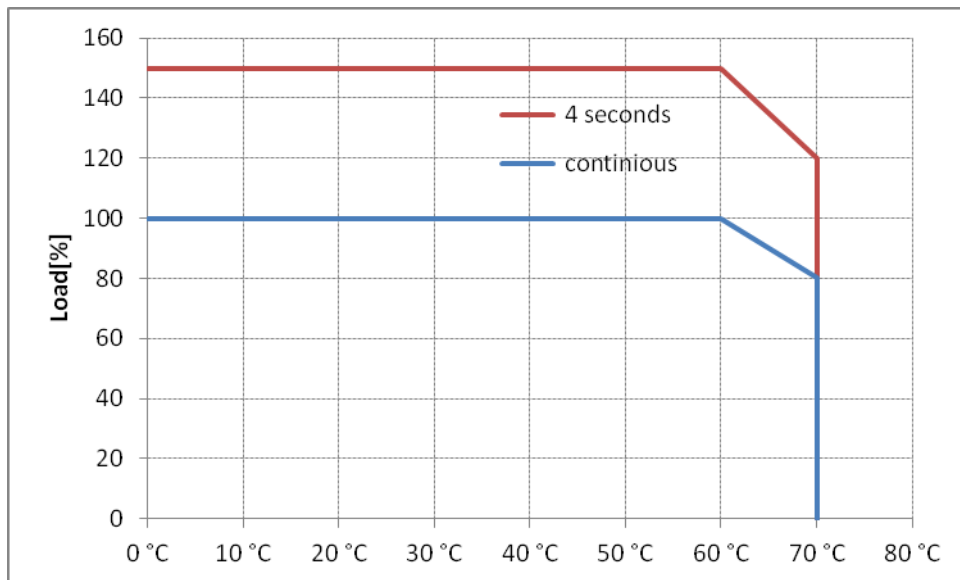

Derating: Load vs ambient temperature

Outline Dimensions

TIB 080:

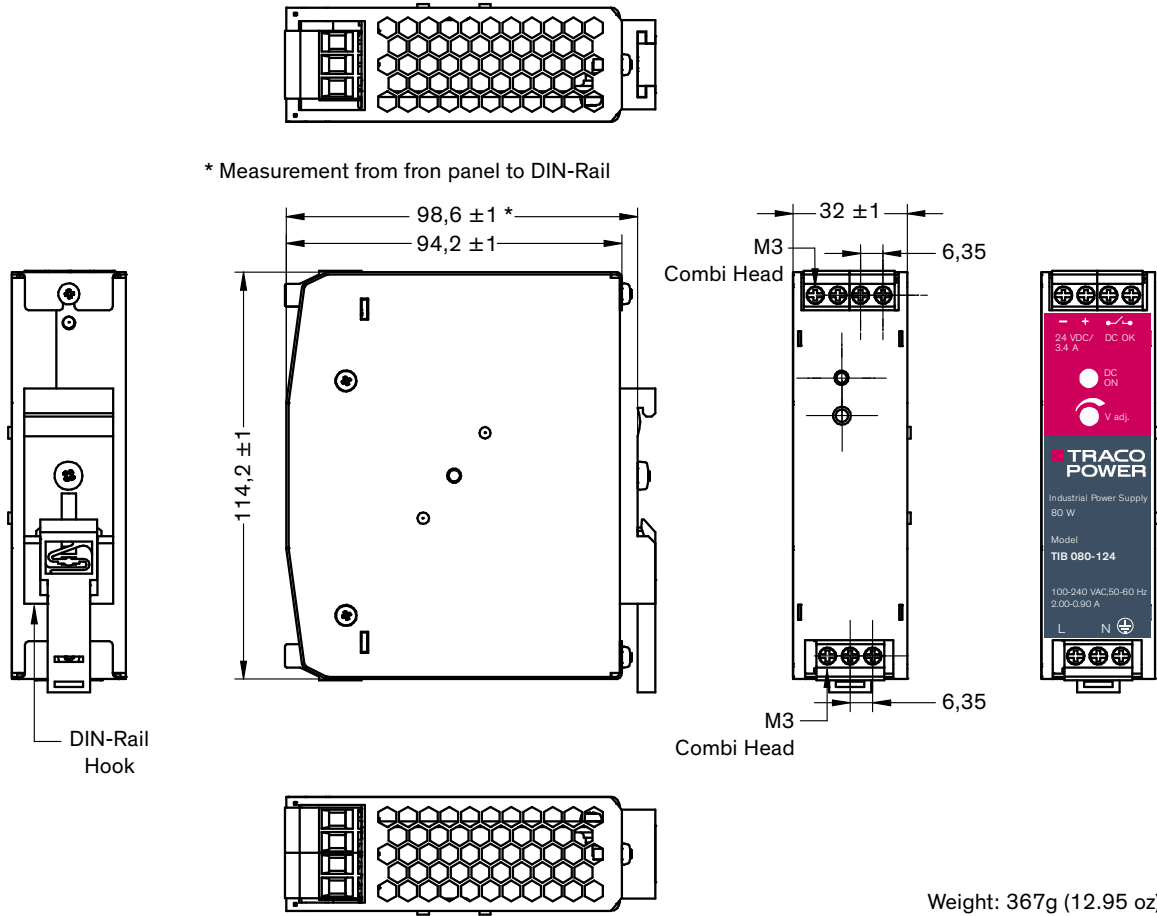

Alternative side mounting:

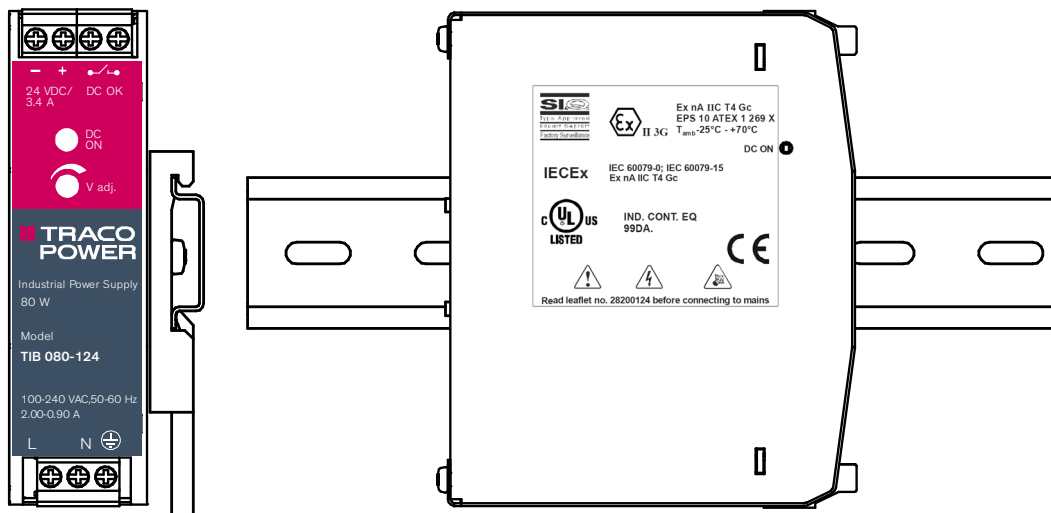

Outline Dimensions

TIB 120:

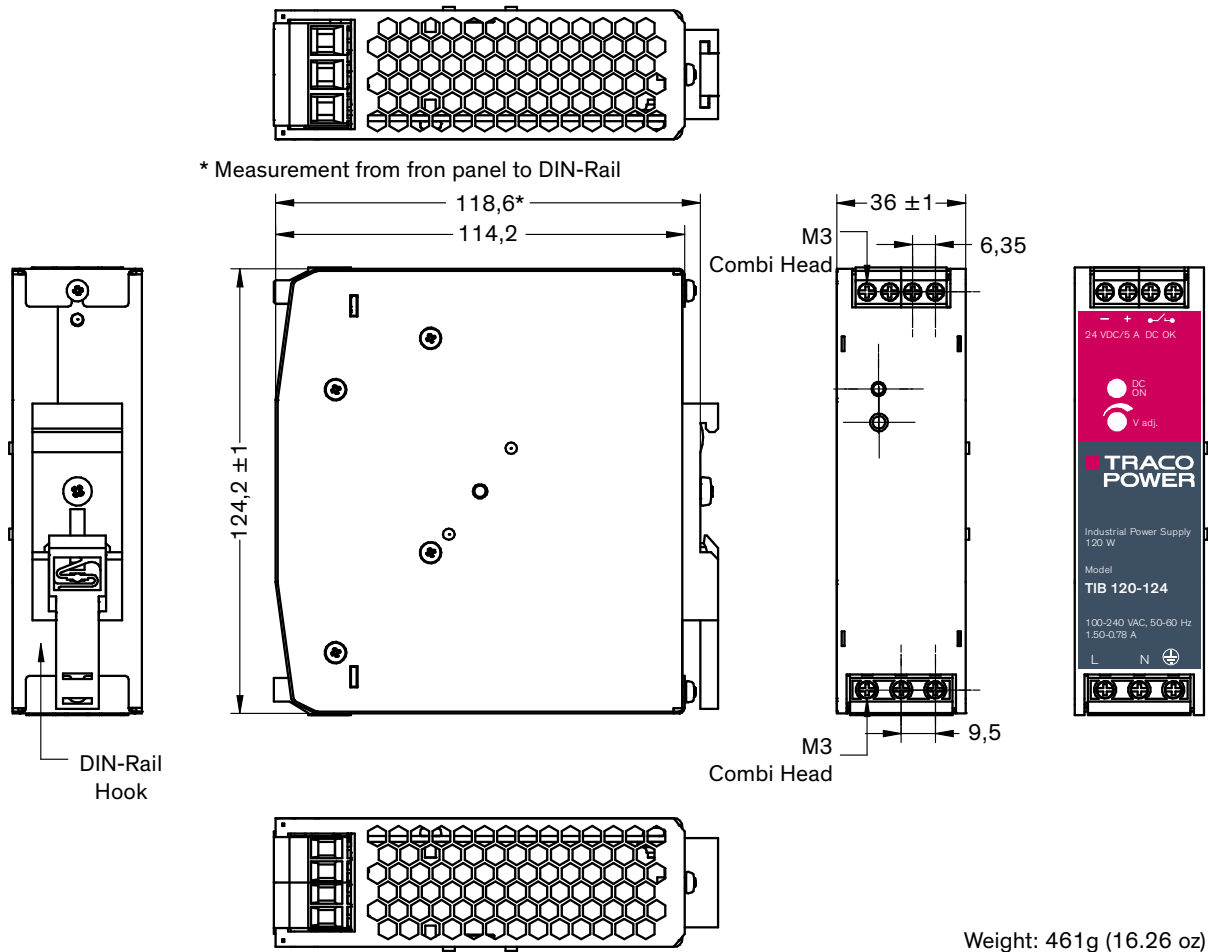

Weight: 461g (16.26 oz)

Alternative side mounting:

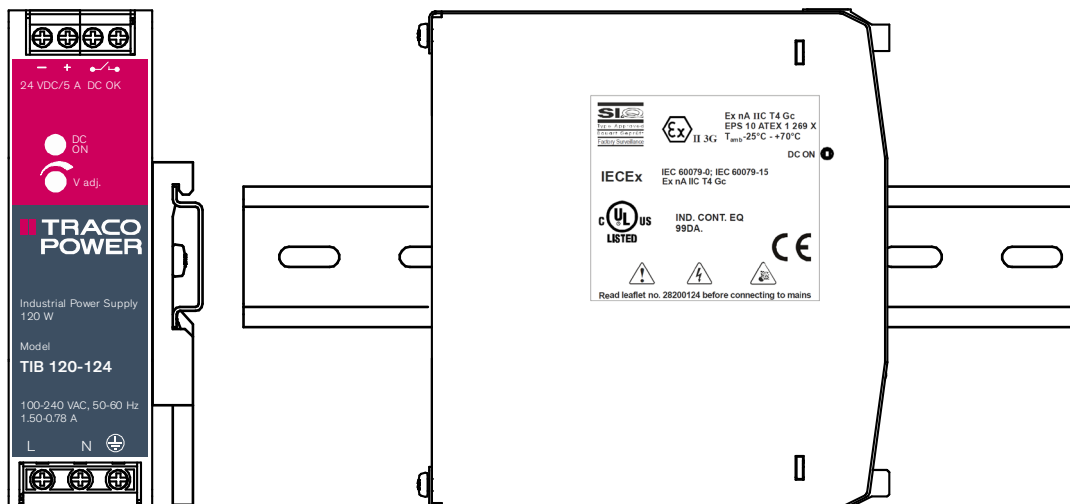

Outline Dimensions

TIB 240:

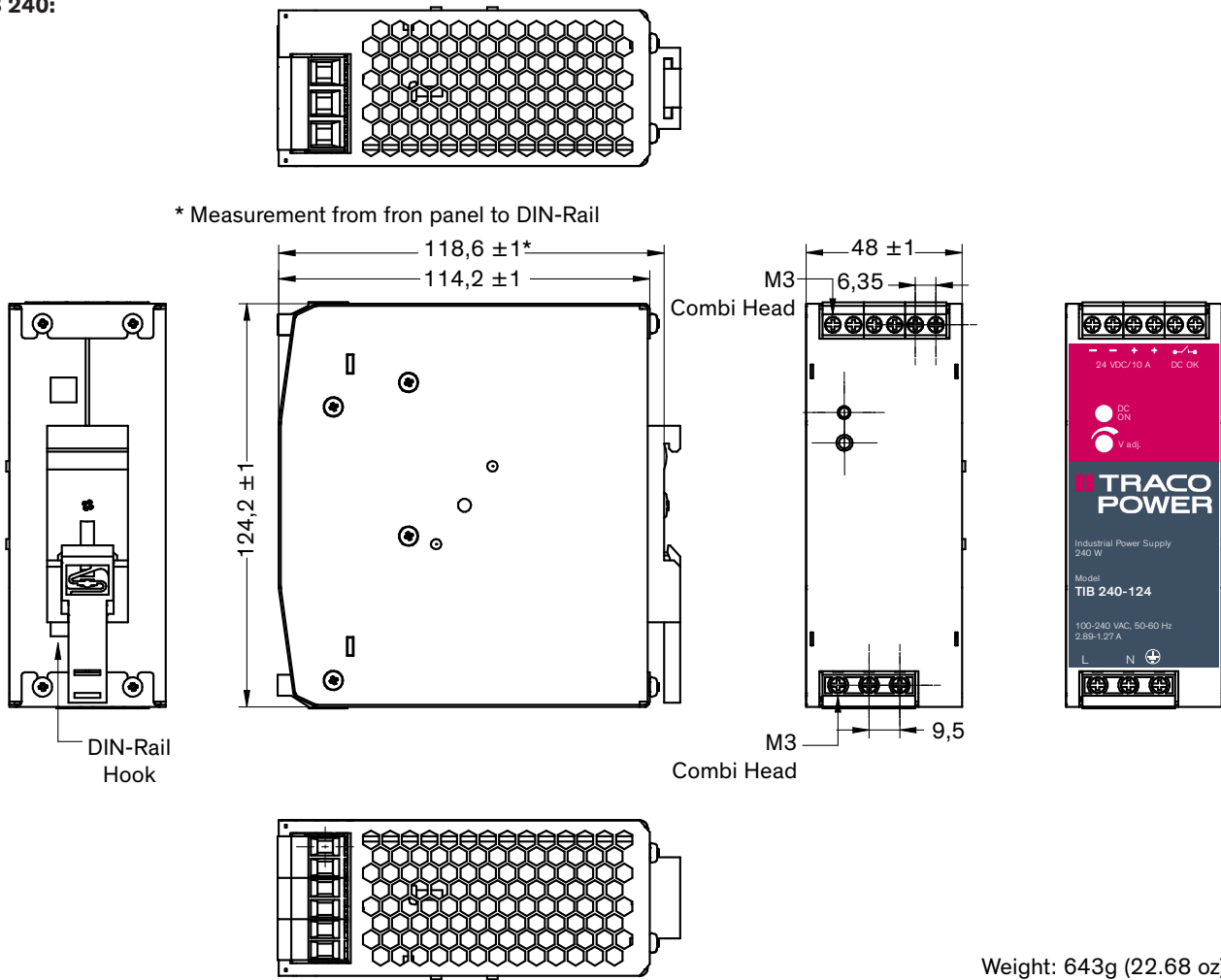

Alternative side mounting:

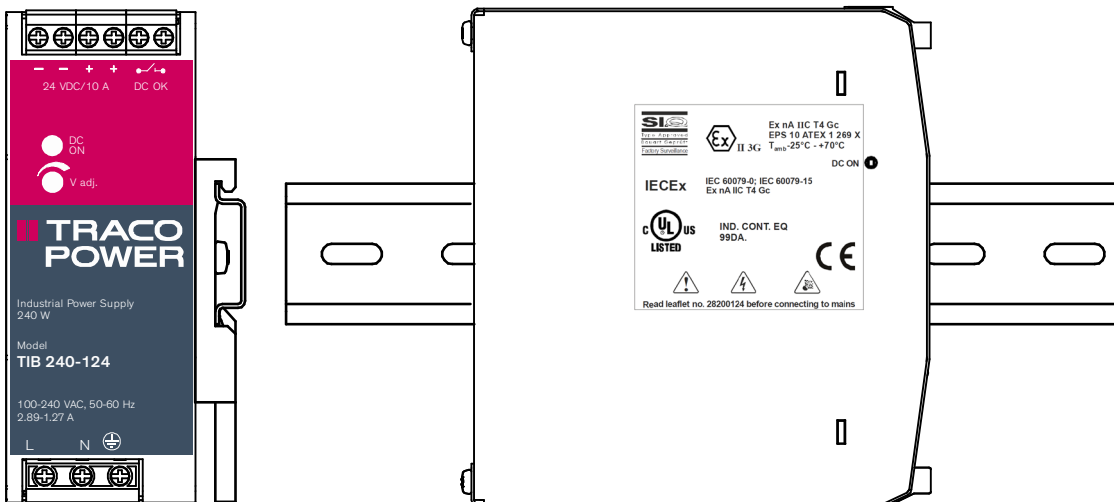

Outline Dimensions

TIB 480:

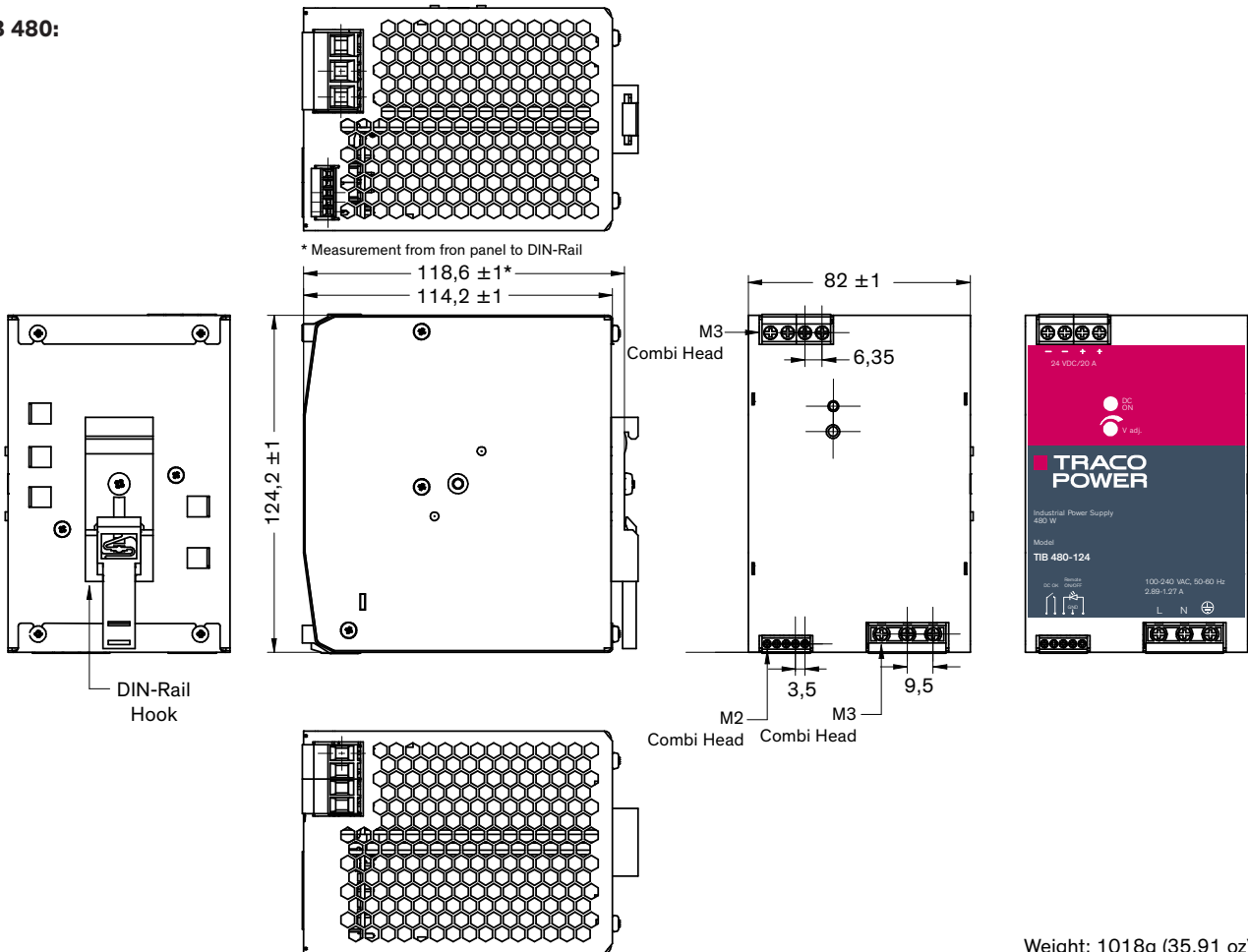

Weight: 1018g (35.91 oz)

Alternative side mounting:

