

NON-ISOLATED DC/DC CONVERTERS

8.3 Vdc - 14 Vdc Input

0.75 Vdc - 5.0 Vdc/3 A Output

bel
POWER PRODUCTS

SRBA-03A1Ax

RoHS Compliant

Rev.A

- Non-Isolated
- Fixed Frequency
- High Efficiency
- High Power Density
- Active Low/High (Option)
- Under-Voltage Lockout (UVLO)
- OCP/SCP
- Remote On/Off
- Wide Trim Range
- Wide Input Range

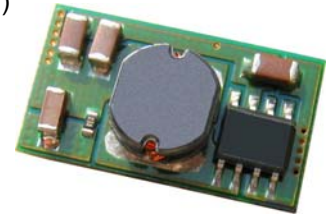

Description

The Bel SRBA-03A1Ax modules are a series of non-isolated dc/dc converters that deliver up to 3 A of output current with full load efficiency of 93% at 5.0 Vdc output. These modules provide precisely regulated voltage programmable via external resistor from 0.75 Vdc to 5.5 Vdc over a wide range of input voltage. Their open-frame construction and small footprint enable designers to develop cost and space-efficient solutions. Standard features include remote On/Off, programmable output voltage, over-temperature protection, over current protection, short circuit protection, and under-voltage lockout.

Part Selection

Output Voltage	Input Voltage	Max. Output Current	Max. Output Power	Typical Efficiency at 5.0V	Model Number Active High	Model Number Active Low
0.75 V - 5.0 V	8.3 V - 14 V	3 A	15 W	93%	SRBA-03A1A0	SRBA-03A1AL

Notes: 1. Add "G" suffix at the end of the model number to indicate Tray Packaging.

2. All part numbers above indicate RoHS 6. Change the second letter "R" to "7" for RoHS 5 part numbers.

Absolute Maximum Ratings

Parameter	Min	Typ	Max	Notes
Input Voltage (continuous)	-0.3 V	-	15 V	
Output Enable Terminal Voltage	-0.3 V	-	15 V	
Ambient Temperature	-40 °C	-	85 °C	
Storage Temperature	-55 °C	-	125 °C	

Note: All specifications are typical at 25°C unless otherwise stated.

Input Specifications

Parameter	Min	Typ	Max	Notes
Input Voltage	8.3 V	12 V	14 V	
Input Current (full load)				
Vo=5.0 V	-	1.35 A	2.00 A	
Vo=3.3 V	-	0.90 A	1.30 A	
Vo=0.75 V	-	0.24 A	0.35 A	
Input Current (no load)				
Vo=5.0 V	-	55 mA	65 mA	
Vo=3.3 V	-	40 mA	50 mA	
Vo=0.75 V	-	15 mA	20 mA	

NON-ISOLATED DC/DC CONVERTERS

8.3 Vdc - 14 Vdc Input

0.75 Vdc - 5.0 Vdc/3 A Output



Input Specifications (continued)

Parameter	Min	Typ	Max	Notes
Remote Off Input Current	-	3 mA	6 mA	
Input Reflected Ripple Current (pk-pk) Vo=5.0 V Vo=3.3 V Vo=0.75 V	- - -	75 mA 50 mA 20 mA	120 mA 90 mA 35 mA	Tested with two 100 uF/25 V tantalum input capacitors & simulated source impedance of 1 uH, 5 Hz to 20 MHz.
Input Reflected Ripple Current (rms) Vo=5.0 V Vo=3.3 V Vo=0.75 V	- - -	20 mA 15 mA 5 mA	60 mA 30 mA 15 mA	
I ² t Inrush Current Transient	-	0.01 A ² s	0.02 A ² s	
Turn-on Voltage Threshold	7.6V	7.9 V	8.2 V	
Turn-off Voltage Threshold	7.0V	7.8 V	8.1 V	

Output Specifications

Parameter	Min	Typ	Max	Notes
Output Voltage Set Point	-2% Vo,set	-	2% Vo,set	Vin=12 V, Io=Iomax, full load
Output Voltage Set Point	-2.5% Vo,set	-	3.5% Vo,set	Over all operating input voltages, resistive loads and temperature conditions
Load Regulation	0.5% Vo,set	0.4% Vo,set	0.5% Vo,set	Io=Iomin to Iomax
Line Regulation	0.4% Vo,set	0.3% Vo,set	0.4% Vo,set	Vin=Vinmin to Vinmax
Regulation Over Temperature (-40 °C to +85 °C)	-	0.5% Vo,set	0.8% Vo,set	
Output Current	0 A	-	3 A	
Current Limit Threshold	5 A	-	12 A	
Short Circuit Surge Transient	-	0.15 A ² s	-	
Ripple and Noise (pk-pk) Vo=5.0 V Vo=3.3 V Vo=0.75 V	- - -	65 mV 45 mV 20 mV	100 mV 80 mV 35 mV	Tested with 0-20 MHz, with 10 uF/10 V tantalum capacitor and 1uF/10 V ceramic capacitor at the output
Ripple and Noise (rms) Vo=5.0 V Vo=3.3 V Vo=0.75 V	- - -	20 mV 10 mV 5 mV	40 mV 25 mV 15 mV	
Turn on Time	-	5 mS	8 mS	
Overshoot at Turn on	-	0%	3%	
Output Capacitance	0 uF	-	1200 uF	
Transient Response				
50% ~ 100% Max Load	All	-	200 mV	300 mV
Settling Time		-	50 uS	80 uS
100% ~ 50% Max Load		-	200 mV	300 mV
Settling Time		-	50 uS	80 uS

Note: All specifications are typical at nominal input (Vin=12 V), full load at 25 °C unless otherwise stated.

NON-ISOLATED DC/DC CONVERTERS

8.3 Vdc - 14 Vdc Input

0.75 Vdc - 5.0 Vdc/3 A Output



General Specifications

Parameter	Min	Typ	Max	Notes
Efficiency Vo=5.0 V Vo=3.3 V Vo=0.75 V	90% 88% 76%	93% 91% 80%	- - -	Measured at Vin=12 V, full load (Current Source)
Switching Frequency	-	300 kHz	-	
Over Temperature Shutdown	-	135 °C	-	
MTBF	6,740,000 hours			Calculated Per Bell Core SR-332 (Io = 80% load; Ta = 25 °C)
Dimensions (Surface Mount) Inches (L × W × H) Millimeters (L × W × H)	0.8 x 0.45 x 0.251 20.32 x 11.42 x 6.38			
Weight	-	3 g	-	

Note: All specifications are typical at 25 °C unless otherwise stated.

Control Specifications

Parameter	Min	Typ	Max	Notes
Remote On/Off				
Signal Low (Unit Off)	-0.3 V	-	0.4 V	SRBA-03A1A0; Remote On/Off pin open, Unit on.
Signal High (Unit On)	2.5 V	-	14 V	
Signal Low (Unit On)	-0.3 V	-	0.4 V	SRBA-03A1AL; Remote On/Off pin open, Unit on.
Signal High (Unit Off)	2.5 V	-	14 V	
Output Voltage Trim Range (Wide Trim)	0.7525 V	-	5.0 V	

NON-ISOLATED DC/DC CONVERTERS

8.3 Vdc - 14 Vdc Input

0.75 Vdc - 5.0 Vdc/3 A Output

bel
POWER PRODUCTS

Remote Enable Specifications

The SRBA-03A1AL modules feature an enable pin with negative logic. If not using the enable pin, leave the pin open (the module will be on). During logic_high, the module is turned off, during logic_low, the module is turned on. Its inner circuit impedance is shown as figure.

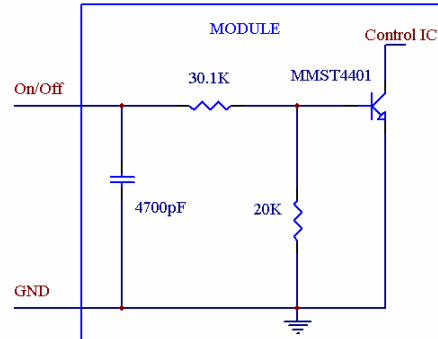

SRBA-03A1AL

The SRBA-03A1A0 modules feature an enable pin with Positive logic. If not using the enable pin, leave the pin open (the module will be on). During logic_high, the module is turned on, during logic_low, the module is turned off. Its inner circuit impedance is shown as figure.

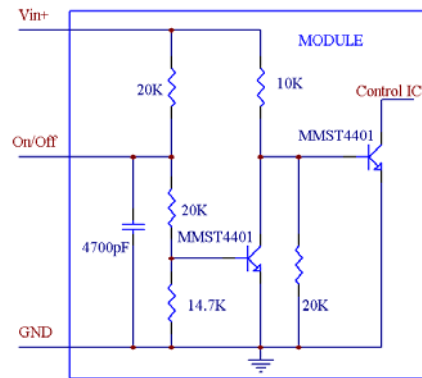

SRBA-03A1A0

Output Trim Equations

Equation for calculating the trim resistor (in kΩ) given the desired adjusted voltage (V_{adj}) is shown below. The Trim Up resistor should be connected between the Trim pin and Ground.

$$R_{trim} = \frac{10.507}{V_{adj} - 0.7525} - 1$$

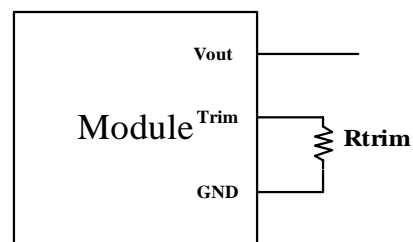

Equation for calculating the trim voltage (in V) given the desired adjusted voltage (V_{adj}) is shown below. The Trim Up voltage should be connected between the Trim pin and Ground.

$$V_{trim} = 0.7 - 0.0667 \times (V_{adj} - 0.7525)$$

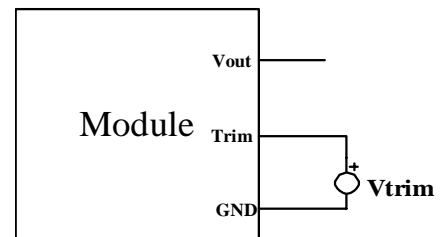

NON-ISOLATED DC/DC CONVERTERS

8.3 Vdc - 14 Vdc Input

0.75 Vdc - 5.0 Vdc/3 A Output



Efficiency Data

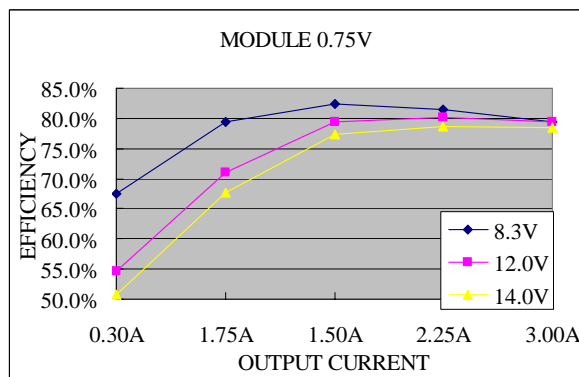
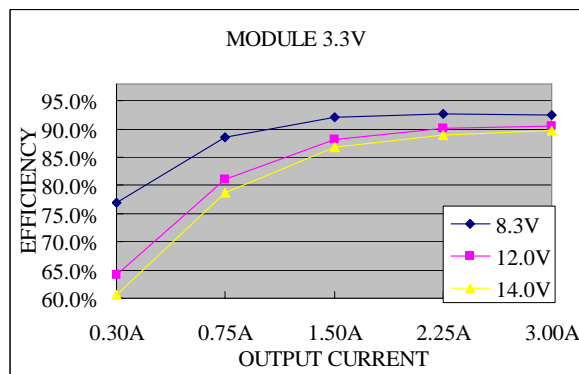
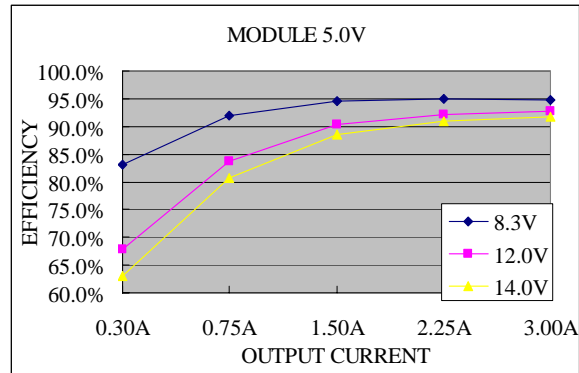

NON-ISOLATED DC/DC CONVERTERS

8.3 Vdc - 14 Vdc Input

0.75 Vdc - 5.0 Vdc/3 A Output

bel
POWER PRODUCTS

Thermal Derating Curves

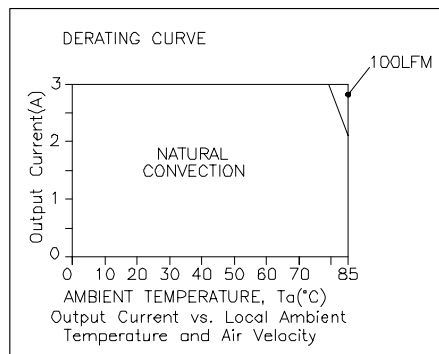

Vin=12 V, Vo=5.0 V

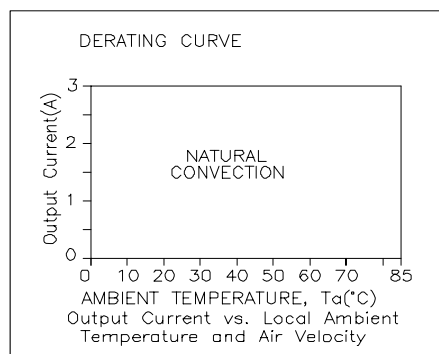

Vin=12 V, Vo=3.3 V

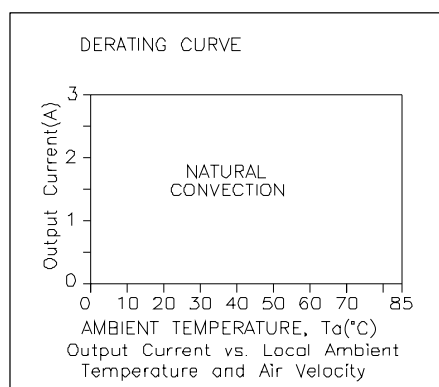

Vin=12 V, Vo=0.75 V

NON-ISOLATED DC/DC CONVERTERS

8.3 Vdc - 14 Vdc Input

0.75 Vdc - 5.0 Vdc/3 A Output



Ripple and Noise Waveforms

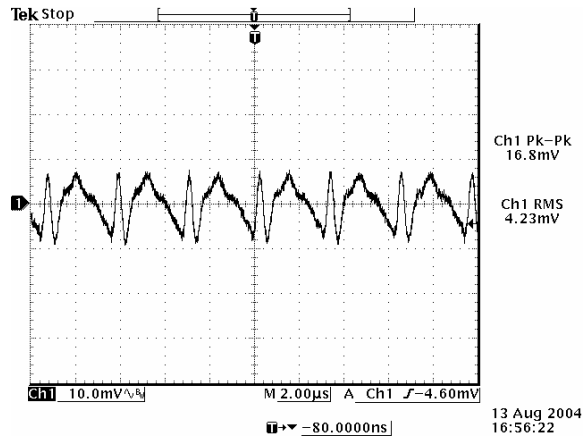

12 Vdc input, 0.75 Vdc output

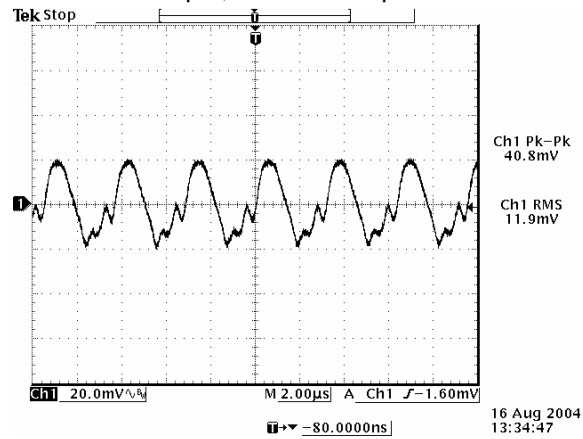

12 Vdc input, 3.3 Vdc output

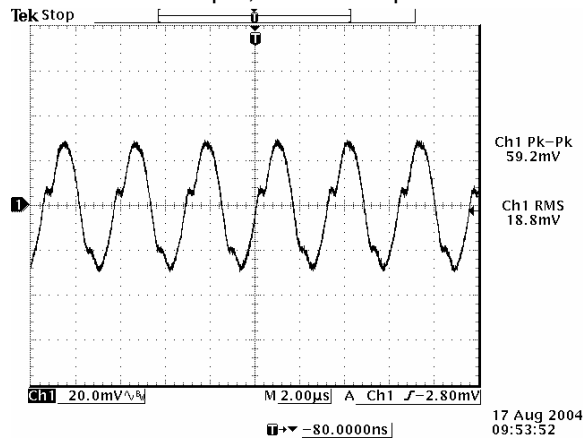

12 Vdc input, 5.0 Vdc output

Note: Ripple and noise at full load, 0-20 MHz BW, with 10 μ F/10 V tantalum cap and 1 μ F/10 V ceramic cap at the output, and $T_a=25$ deg C.

NON-ISOLATED DC/DC CONVERTERS

8.3 Vdc - 14 Vdc Input

0.75 Vdc - 5.0 Vdc/3 A Output



Transient Response Waveforms

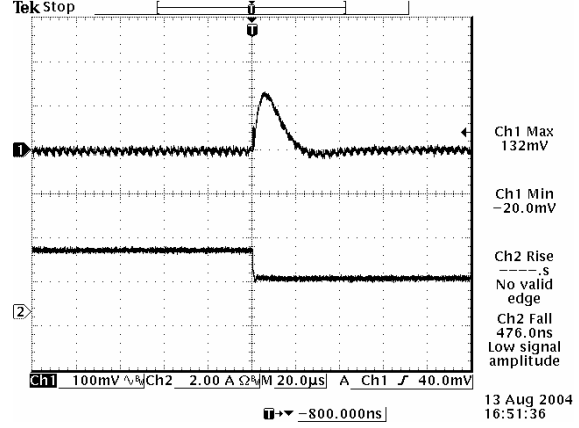
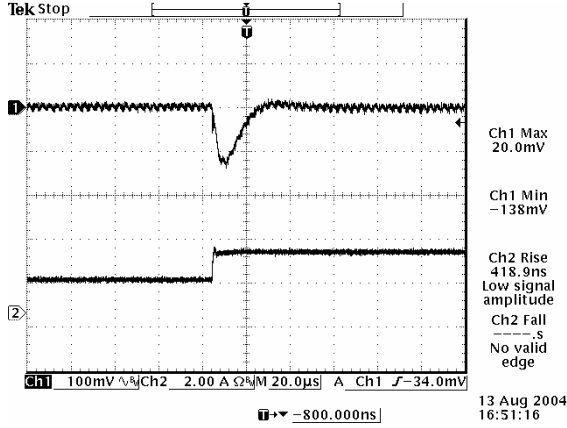

Transients 50% to 100% load 0.75 Vdc output

Transients 100% to 50% load 0.75 Vdc output

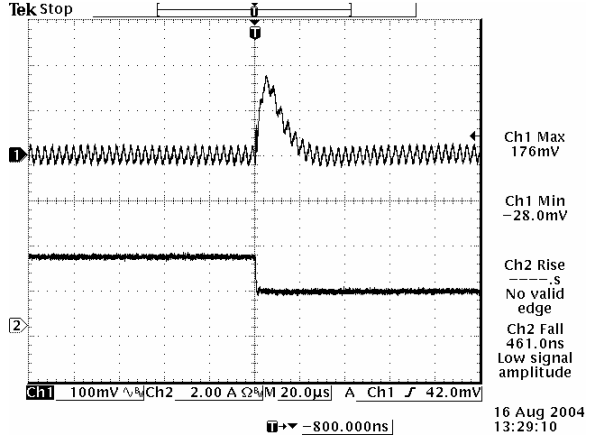
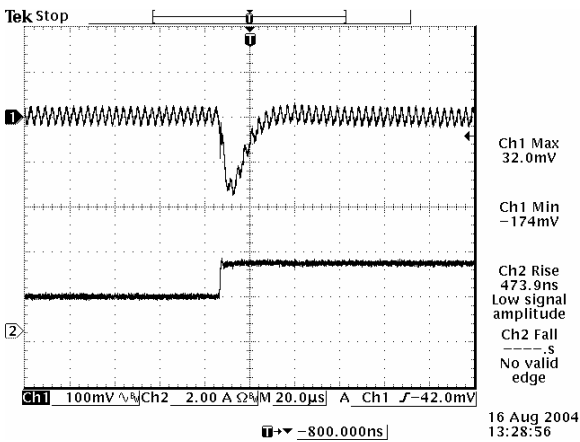

Transients 50% to 100% load 3.3 Vdc output

Transients 100% to 50% load 3.3 Vdc output

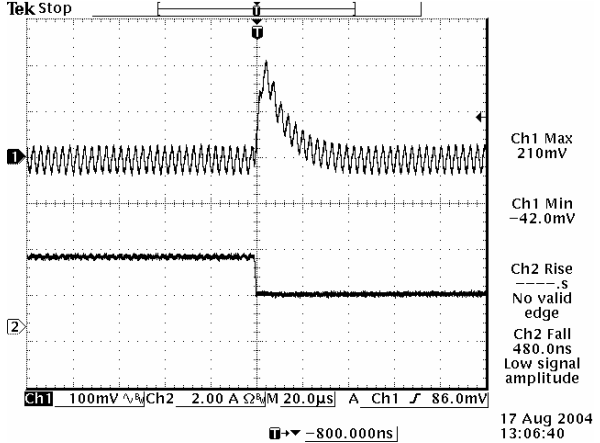
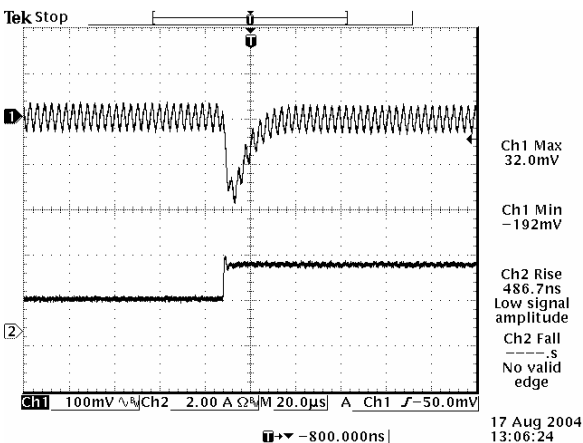

Transients 50% to 100% load 5.0 Vdc output

Transients 100% to 50% load 5.0 Vdc output

Note: Transient response at 12 Vdc input, di/dt=2.5 A/uS, with 10 uF/10 V tantalum cap and 1 uF/10 V ceramic cap at the output, Ta=25 deg C.

NON-ISOLATED DC/DC CONVERTERS

8.3 Vdc - 14 Vdc Input

0.75 Vdc - 5.0 Vdc/3 A Output



Mechanical Outline

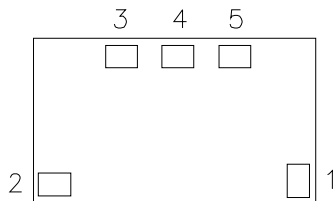
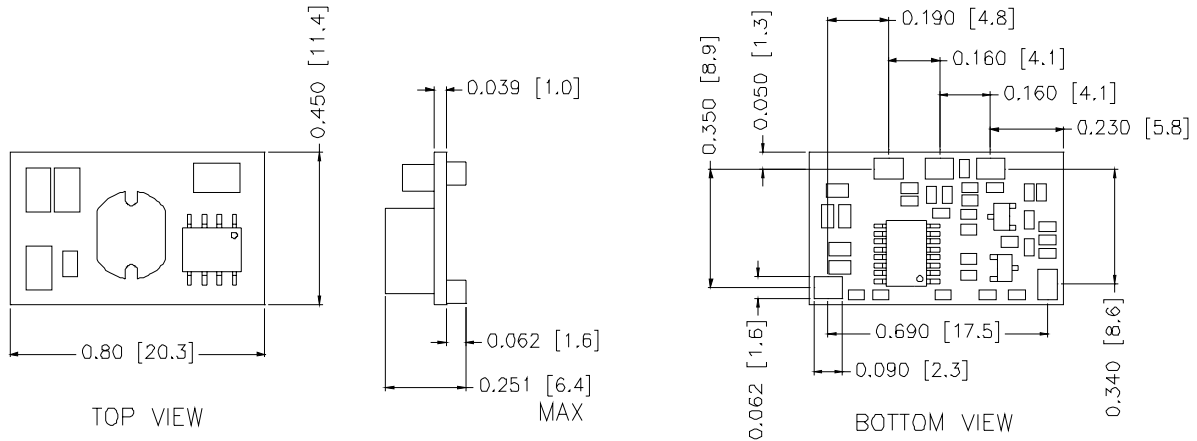

Pin Connections

Pin	Function
1	Remote On/Off
2	Vin
3	Ground
4	Trim
5	Vout

RECOMMENDED PAD LAYOUT

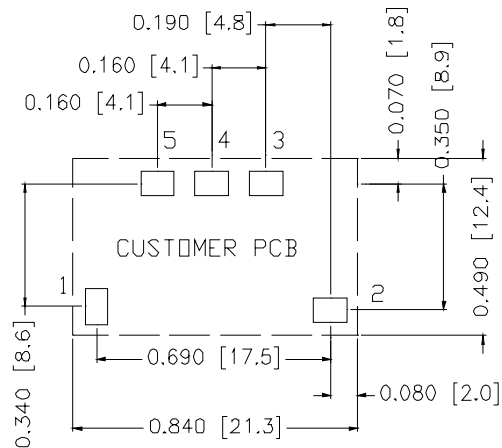

PAD SIZE:
 MIN: 0.12" * 0.095" (3.05mm * 2.41mm)
 MAX: 0.135" * 0.11" (3.43mm * 2.79mm)

RoHS Compliance

Complies with the European Directive 2002/95/EC, calling for the elimination of lead and other hazardous substances from electronic products.



©2007 Bel Fuse Inc. Specifications subject to change without notice. 011507

CORPORATE

Bel Fuse Inc.
 206 Van Vorst Street
 Jersey City, NJ 07302
 Tel 201-432-0463
 Fax 201-432-9542
www.belfuse.com

FAR EAST

Bel Fuse Ltd.
 8F/ 8 Luk Hop Street
 San Po Kong
 Kowloon, Hong Kong
 Tel 852-2328-5515
 Fax 852-2352-3706
www.belfuse.com

EUROPE

Bel Fuse Europe Ltd.
 Preston Technology Management Centre
 Marsh Lane, Suite G7, Preston
 Lancashire, PR1 8UD, U.K.
 Tel 44-1772-556601
 Fax 44-1772-888366
www.belfuse.com